

## Axio Scope

More functional. More economical.



The adaptable all-round stand for  
your routine and research applications



We make it visible.

## Your Axio Scope

More functional in every component.

More economical in every configuration.

Axio Scope is your microscope down to the last detail.

Modularity has always been a prerequisite for customized microscope configurations. However, modularity has never before been implemented so consistently. The new all-round stand from Carl Zeiss is your microscope in every respect. With its unusual flexibility, it can be used universally – and is yet individually tailored to your applications. More economical than ever because you only buy what you need at the moment. And because you have the option of extending your microscope to meet your growing demands. You will be equally impressed by the cost benefits and the performance. Axio Scope – the latest generation upright routine microscope.

# Contents

Flexibility	6-7
Transmitted-light Techniques	8-9
Fluorescence	10-11
Fluorescence LED	12-13
Objectives	14
Imaging System	15
Specimen Space	16-17
Operating Comfort	18-19
Axio Scope: System Overviews	20-24
The New Functionality: All the Advantages	25





# Flexibility

**Twenty-three Stand Versions. Innumerable Interfaces.  
An Outstanding Solution for Your Applications and Budget.**

An unusual number of stand versions and interfaces results in unusual flexibility. This means that you can configure your Axio Scope whatever way is useful for you. Functionally and economically.

## New modularity

Axio Scope is as individual as the applications that you use it for. You can customize your stand from five upper parts, three lower parts and two vario columns. For simple or more complex tasks. For transmitted-light, reflected-light or fluorescence. What is important is that you no longer invest in functions that you don't even use – a tangible advantage for your budget.

## Economical upgrading

Simpler and less costly – the modular interface concept of Axio Scope makes future upgrading quite simple. This is economically attractive as you can install many of the components yourself without waiting for expensive service support.

## Versatile range of uses

Axio Scope provides a range of uses which are as versatile as the tasks in institutes and laboratories. They range from simple routine applications to more complex research projects. From anatomy to cytology. From transmitted-light applications to multi-fluorescence labelling. From the thinnest histological section to a specimen 380 mm thick.

## The upper parts

- I. For pure transmitted-light applications  
Equipment: objective turret with 6x BF
- II. For standard fluorescence applications  
Equipment: objective turret with 3x DIC/3x BF, standard interface for HBO 50, HBO 100, HXP 120, Colibri etc.
- III. For LED fluorescence applications  
Equipment: objective turret with 3x DIC/3x BF, integrated illumination that can accept 4 different LED modules, synchronized switching with the reflector turret, long operating life, highly economical
- IV. For reflected-light and fluorescence applications  
Equipment: objective turret 6x BF/DF, standard interface for HAL 100 or HBO, DF insert in the objective turret, switchable diffuser
- V. For reflected-light and fluorescence applications  
Equipment: objective turret 6x DIC/DF, standard interface for HAL 100 or HBO, DF insert in the objective turret, switchable diffuser, accessible aperture and field diaphragm levels, slot for polarizer slider

BF = Brightfield, DF = Darkfield, DIC = Differential Interference Contrast



The new variety of interfaces shown here, using the example of upper part III and lower part B. They vary according to the upper and lower parts.

- 1 Reflector space
- 2 Tube
- 3 Eyepiece
- 4 Camera adapter
- 5 Camera
- 6 HBO adjustment aid
- 7 Reflected-light filter slider
- 8 Achromatic illumination adapter
- 9 Reflected-light source
- 10 Upper part/lower part
- 11 Spacer
- 12 Lower part/upper part
- 13 Transmitted-light filter slider
- 14 Transmitted-light filter wheel
- 15 Condenser carrier
- 16 Condenser
- 17 Modulator disc
- 18 Stage
- 19 Stage carrier
- 20 Objective

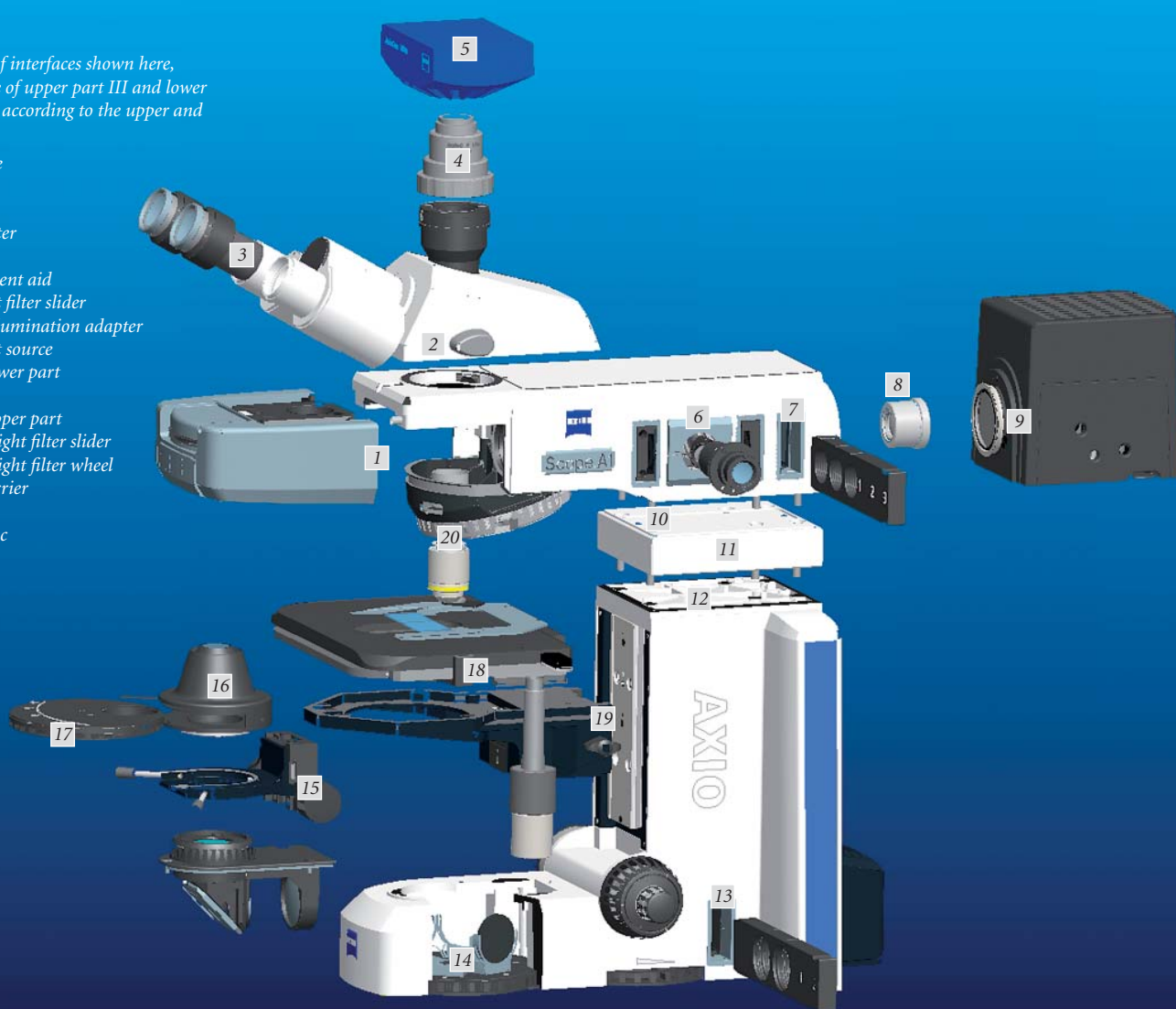

### The lower parts

- A. For many routine applications  
Illumination: LED (Fixed-Koehler), screwed in directly beneath the condenser carrier
- B. All standard applications  
Illumination: 50 W reflector light, koehlerable beam path with field diaphragm and aperture diaphragm, filter slider and 6-position filter wheel
- C. For demanding transmitted-light applications with high-intensity illumination  
Illumination: 100 W halogen, koehlerable beam path with field diaphragm and aperture diaphragm, filter slider and 6-position filter wheel

### The stand columns

- For examination of thick specimens
- D. Vario column 380 mm for reflected-light and fluorescence applications
- E. Vario column 560 mm for reflected-light and fluorescence applications



# Transmitted-light Techniques

**LED or Halogen, Phase Contrast or DIC. Never Before has a Microscope of This Class Offered so Many Possibilities.**

Whether unstained cells, histologically dyed sections or bone samples: transmitted-light techniques continue to be the standard for many examinations in the clinical area. The interfaces developed for the Axio Scope are unique. This brings completely new flexibility into routine microscopy.

## All contrasting techniques

Surprising in this microscope class: the sheer variety of contrasting techniques that you can use for your applications. Axio Scope offers you simply everything. The classical methods of brightfield, darkfield, phase contrast – but also Differential Interference Contrast, DIC for short. You can also use the economical PlasDIC alternative from Carl Zeiss. Which means that this inexpensive interference contrasting technique is available for the first time with an upright microscope.

## Individual configuration: the transmitted-light beam path

The transmitted-light beam path of Axio Scope provides impressive image contrast and homogeneous illumination. The great flexibility in configuring offered by Axio Scope is new and unique. At the front you have a 6-position filter wheel, which comes equipped with the integrated shutter. Individual grey and colour filters can easily be added. At the back you can also use an additional filter slider, which can also be configured flexibly so that nearly any combination of filters is possible. Moreover, if you decide on transmitted-light LED illumination, attenuating filters are unnecessary. The economical LED illumination can be attenuated as desired without any change in colour temperature – a genuine advantage compared to halogen light.

*Versatile options: the LED components (1), the Abbe condenser with/without modulator disc (2), and the modulator disc with exchangeable modules for darkfield, phase contrast or PlasDIC techniques (3).*

*It's easy to change to darkfield, phase contrast and PlasDIC: the interfaces in the Abbe condenser and modulator disc provide a unique range of contrasting techniques. Simply by inserting the modules.*





*The 6x filter wheel comes equipped with an integrated shutter. Grey and colour filters can be mounted individually – easily and conveniently since the filters are clicked readily into the corresponding holders when the cover is open.*

### **LED or halogen? Standard illumination**

You can choose among three subunits optimized for the different geometries of the light sources. 1. Transmitted-light LED: durable, economical and adjustment-free, this illumination provides sufficient intensity for stained histological preparations and other typical routine clinical tasks. 2. 50 W reflector illumination: this offers more than enough light for all standard procedures such as brightfield and phase contrast. 3. 100 W halogen light, ideal for thick specimens and procedures that require a lot of light, such as DIC at high magnifications.

### **Flexible for interference contrast: the Abbe condenser**

The possibility of equipping Axio Scope with anything from a very inexpensive bright field condenser to a high-performance interference contrasting technique is new and unique in this class. This is made possible by two unusual interfaces: you simply equip your condenser with the modulator disc for darkfield and phase contrast when you need these methods. The modulator disc itself has exchangeable modules. This allows you to use even PlasDIC, the inexpensive interference contrast from Carl Zeiss, at any time, simply by exchanging the modules.

### **ISCP: the Infinity Space Camera Port**

For all documentation tasks in transmitted-light applications and only with Axio Scope: the Infinity Space Camera Port, ISCP for short. This innovative feature offers you an additional option for using the interface in the infinity space (see also infinity space interface on pages 10/11). Instead of using this for reflected-light reflectors, you can use it for your applications in transmitted-light. That way, you gain a fully functioning camera port, independent of the choice of tube that can be added at any time.

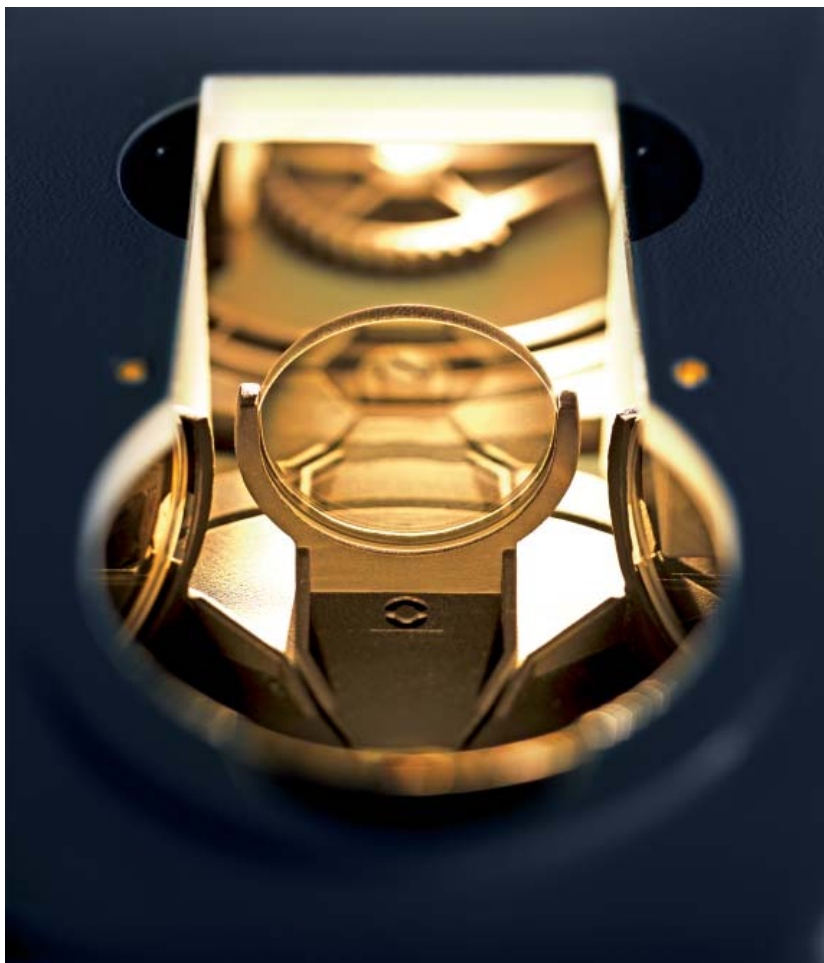

*ISCP – the Infinity Space Camera Port – is simply inserted in the interface in the infinity space. For transmitted-light, it is a fully functioning camera port, that can be added any time.*

# Fluorescence

## Configured Today. Adapted Tomorrow. The New Fluorescence Grows With Your Demands.

FluoresScience is the name of the initiative reflecting Carl Zeiss' focus on the development of excellent fluorescence techniques. The latest developments of this initiative reflect the growing importance of fluorescence as a routine method. With outstanding quality, innovative solutions and its ability to be configured to meet requirements down to the smallest detail, Axio Scope sets quite new signals in its class.

### Can be retrofitted to meet your needs: the reflected-light beam path

Axio Scope is excellently equipped for fluorescence because the reflected-light beam path was completely recalculated to provide outstanding contrast and excellent minimizing of scattered light. On the other hand, you can benefit from the great flexibility of the modular system here. The adjustment aid for the HBO can be added – you can simply insert it yourself. The same applies to the achromatic system, which guarantees you even better results in Multichannel Fluorescence applications.

### Interface for your reflector inserts: infinity space

Unique in this class: the interface in the infinity space. With Axio Scope you can select the reflector turret or slider required for your applications. Flexible, simple and quickly added. You have a choice of a 2x slider or a reflector turret with 4 or 6 positions. In addition, Axio Scope offers another feature here as the interface can also be used as a camera port for transmitted-light applications (see Infinity Space Camera Port, pages 8/9).



Exchangeable: the standard lens system and the achromatic system for Multichannel Fluorescence applications.



The interface in the infinity space allows diverse uses: the 6x and 4x reflector turret, the Infinity Space Camera Port (ISCP) and the 2x reflector slider.



An option that can be added simply: the adjusting aid for setting the HBO burner.

**Versatile and innovative: the light sources**

The illumination options of Axio Scope are versatile and simple for the customer to operate. A completely new lamp housing was developed for the HBO 50, whose burner can be removed with the drawer for a particularly simple and convenient change of burner. The HBO 100 comes as a standard or in a self-adjusting version. In addition to HBO illuminators the HXP 120 provides you with a durable, adjustment-free metal halide light source with integrated fast shutter, which can be controlled simply by a hand or foot switch or from AxioVision.



*Simpler than ever: changing the burner in the newly developed HBO 50 lamp housing.*

*Inserting the reflector slider, reflector turret or ISCP in the infinity space on the vario stand: just one simple movement of your hand.*



## Fluorescence LED

**Completely New. Completely Integrated. With This Innovative Light Source Axio Scope Sheds New Light on Routine Work.**

A technological development, available for the first time with Axio Scope: the integrated LED illumination for routine fluorescence applications. Now you can have these extremely durable and economical light sources in both transmitted-light and reflected-light.

### The new LED

The advantages of LED illumination speak for themselves: extremely long operating life, inexpensive, easy to handle, and completely adjustment-free. And without expensive changes of burner for a very long time – instead of operating constantly, the LEDs turn on only when they are used in the beam path. Now Carl Zeiss offers a new integrated LED solution specially designed for routine applications in fluorescence. The freely mountable LED turret allows you to use up to 4 LED modules. Synchronized with the reflector turret\*, the correct LED is switched on automatically when a new reflector module is swung in. The intensity can be regulated individually for any colour. Your settings are preserved even when you switch back and forth – an important plus because that way each of your different fluorescence channels is optimally illuminated at any time.



*Without a tool, easy, and safe: mounting the LED modules on the LED turret. When the cover is opened, a safety switch ensures that the LED is switched off immediately.*

\* Because of the coupling of reflector turret and LED module turret, the reflector turret is not exchangeable with this upper part.



**Full Flexibility**

The flexible modular concept of Axio Scope leaves you much room for configuring your stand to meet your needs. The upper part with the integrated LED fluorescence (see page 6/7, upper part III) can be combined with all lower parts. If you wish, you simply assemble your complete LED stand with integrated transmitted-light and reflected-light LED.

**Prepared for Colibri**

Axio Scope is prepared for Colibri, the high-end LED fluorescence light source from Carl Zeiss. Thus you have a choice to use a light source, which is fully integrated in the AxioVision software. And so you are able to take automatic Multichannel Fluorescence images – on a purely manual stand!



*Easily accessible: on/off switching and intensity control of the LED modules.*



*Colibri for setting up to four wavelengths simultaneously.*

# Objectives

**New for Routine Work. Tried and Tested for the Highest Demands. Objectives from Carl Zeiss: the Economical Solution for Every Requirement.**

Carl Zeiss stands for more than 150 years for microscope lenses that are practically unrivalled. And this in all performance classes. Naturally highest demands on optical performance were also placed on Axio Scope.



*N-ACHROPLAN objective series: The new inexpensive all-round talent: the N-ACHROPLAN objective series was developed specially for diverse routine applications.*

## Perfect for routine work: the new N-ACHROPLAN objectives

Newly developed and perfect for many of your routine applications: the N-ACHROPLAN series. A very inexpensive all-round objective with good chromatic correction and planarity. Moreover, the entire range of objectives from Carl Zeiss are at your disposal. The decision is up to you; from a low magnification overview to high-resolution imaging of details.

*Unusual in this performance class: the interfaces for DIC. Depending on the upper part, an objective turret with 0, 3 or 6 DIC slide holders is*



## Each class is a class of its own – the objectives

- **A-Plan – the A class:**

Good and inexpensive entry-level objectives for diverse applications; good optical quality for transmitted-light applications

- **N-ACHROPLAN – the all-rounders:**

Inexpensive, versatile and new for many routine applications in transmitted-light or reflected-light

- **EC Plan-NEOFLUAR – the universal talents:**

Perfect when flexibility and a variety of techniques are required. Based on the IC<sup>2</sup>S optics, they are characterized by high-contrast imaging, excellent homogeneity, high resolution, and high transmission.

- **FLUAR – the photon collectors:**

High numerical apertures, good contrast, and outstanding transmission provide you with enormous optical performance. Ideal for rendering the weakest fluorescence visible

- **Plan-APOCHROMAT – the high-performance series:**

Best colour correction and highest numerical apertures for brilliant images in all techniques. Convincing: the outstanding point spread function and spherical correction

*available with Axio Scope. Six objective positions offer you plenty of scope for mounting them to suit your application.*



# Imaging system

**Flexible for the Leading Software and Every Camera Type. The Simple Step from Stand-alone Stand to Documentation System.**

Your Axio Scope Imaging System is more than the sum of microscope, software and camera: a complete solution from a single source. Integrated fully into the Carl Zeiss system approach. With security of one hundred percent compatibility – also for future developments.

### Very convenient: AxioVision microscope software

Easy to operate and functional – with AxioVision you extend your Axio Scope to include digital documentation. The modular microscope software from Carl Zeiss offers you all the important functions in the basic version, from recording and processing to analyzing and archiving your images. AxioVision is one of the leading systems on the market, not least because this software is surprisingly simple to operate despite its wealth of functions. For instance, it is possible to adapt the operating interfaces and functions yourself – ideal for simplifying your routine applications through clear processes, thus making them more efficient. Moreover, you get the AxioVision LE software version free of charge. A good solution that opens up many options in digital photography.



### Great in all performance classes: the cameras

From AxioCam ICc1 or AxioCam ICc3, the smallest and most inexpensive digital colour cameras, to the high-speed AxioCam HS: Axio Scope provides a connection for every type of camera. And Carl Zeiss provides the complete range of modern microscope cameras. Each of them carries the Carl Zeiss seal of quality. Axio Scope is also compatible with digital consumer cameras, e.g. from Canon.

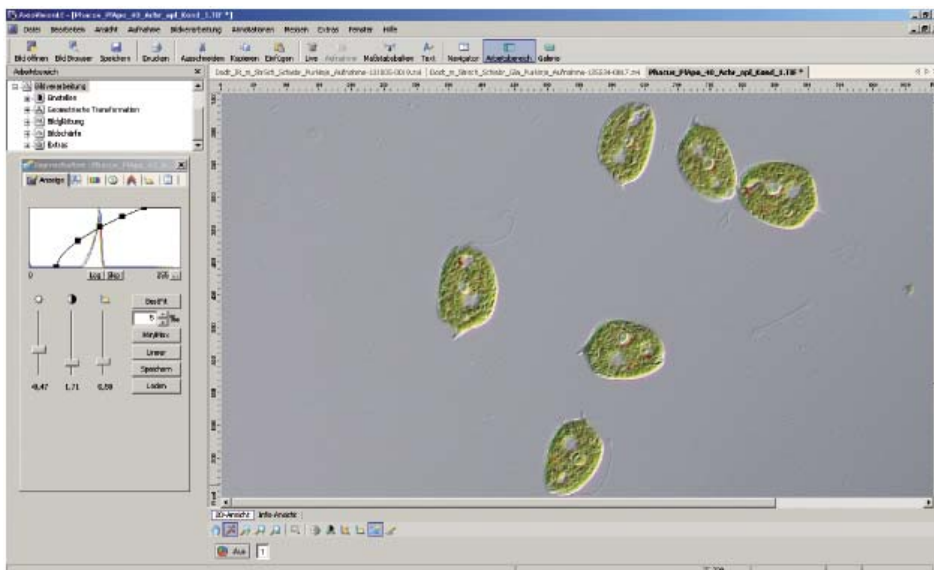

*The free AxioVision LE software provides a variety of high-quality functions for capturing, processing and analyzing images.*

## Specimen space

**Space for Every Specimen. Space for Every Experiment. The Flexibility of the Specimen Space: a Special Feature That You Will Welcome.**

The specimen space can be extended practically as much as you want. A strong plus point, because there are practically no limits with regard to size of specimen. Depending on the configuration the specimen space can be varied continuously: for specimen thicknesses from 0 to 110 mm.



*Flexible option for further extension of the specimen space in z direction: spacer in 30 mm and 60 mm versions.*

### Where there are no limits to height

The great scalability of the specimen space is an important basis for the range of uses of Axio Scope. In addition to the z travel range, it can be influenced in several places. 1. You can simply lower the stage carrier at the dovetail. 2. The condenser carrier can also be removed easily, which is practical when you want to lower the stage over the travel range. 3. You can gain space at the interface between the upper and lower parts by using a spacer. This comes in 30 or 60 mm versions. Depending on the configuration, the specimen space can be extended smoothly by up to 110 mm.

*The modular interface concept allows easy handling, e.g. when using the spacer (30 mm or 60 mm) to enlarge the specimen space.*





### When even more space is needed

If you require even more space for unusually large specimens, e.g. in intravital microscopy, Axio Scope offers two vario stands for your reflected-light and fluorescence applications. Depending on your requirements, you can couple any upper parts to them. A perfect fit for your applications.



*There is virtually no limit to the size of the specimen space: specimens up to 380 mm in size, such as this tree trunk, can be examined with the vario stand columns.*

*The specimen space is continuously adjustable for specimen thicknesses from 0 to 110 mm, simply by adjusting the height of the stage carrier.*



# Operating Comfort

**Convenient to Handle. Efficient in the Workflow. Operating Comfort and Ergonomics Fulfill Almost all Your Needs.**

Developed for 24-hour use, Axio Scope will convince you by its quality and stability. The many intelligent details making your routine work in the laboratory a great deal simpler and more pleasant to work with.



*Well-conceived operating comfort can be found in many elements in Axio Scope: the stage drive of the new ergo-stage, which can be moved in the y direction and fixed in place; the focus drive; the 6x filter wheel with integrated shutter; and the right/left hand intensity adjustment of the transmitted-light illumination.*

## **Well-conceived operating elements**

Simply intelligent – the design of Axio Scope makes operating the stand in routine work as comfortable and safe as possible for you. The intensity setting for the transmitted-light illumination is arranged ergonomically around the focus drive. Positioned on both sides close to the focus drive, it is extremely comfortable to operate. You can now adjust the illumination settings without taking your hand off the drive, with your right or left hand, just as you prefer.

## **New stages**

Axio Scope offers a wide range of different stage versions. Two stage innovations are outstanding. 1. The ergo-stage: it enables you to move the stage drive 90 mm along the y axis into the position that is most comfortable for you. It can be fixed in that position and easily operated, without any need for you to change the position of your hand. 2. The new stage with a light special coating: this innovation is ideal for routine applications with a high throughput of specimens. In other words, when many slides are moved on the stage – which used to be the cause of early wear and tear on the stage surface. The extremely hard coating of the new stage shows no scratches, even in a hardness test.

### Smart slide guide

An intelligent innovation that experienced clinicians in particular will welcome: the slide guide of Axio Scope alternatively allows you to guide the specimen by hand. Designed as a flat plate, it is ideal for pushing your specimen slides back and forth so that you can quickly obtain an overview. If you want to view certain areas at higher magnification, simply let go and use the sensitive stage drive.

### Ergonomic tubes

Designed for long laboratory work days, Axio Scope places a special emphasis on ergonomics. The viewing angles of the ergotubes are based on modern studies and are designed for fatigue-free and healthy posture. Two different models are available. The height-adjustable ergotubes with a travel range of 44 mm or the 50-15-50 ergo-phototube with upright correct-side image, which can be adjusted through 50 mm in height and depth at a fixed viewing angle of 15° so as to be as comfortable as possible for your height. The eyepiece setting can also be varied with both tubes, enabling you to gain an additional 50 mm of height.

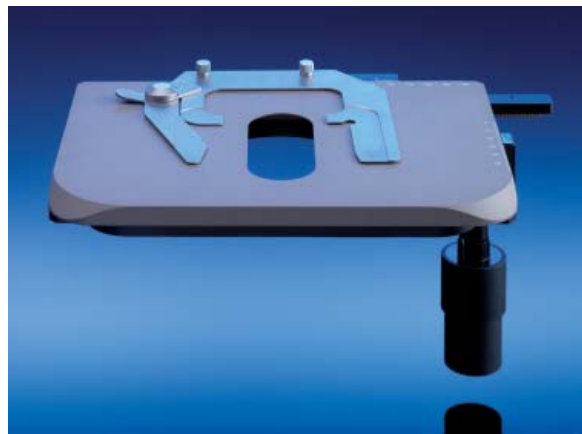

*The extremely durable special coating for toughest continuous use.*

### Conversion without tools

More comfortable, faster, and simply practical – the modular interface concept of Axio Scope is designed so that you can simply remove many components, such as the stage carrier or condenser, without any tools. This simplifies the cleaning process, for example.

### Robust construction

Whether pathology, cytology or histology: in clinical routine work, where specimens are often examined in a 24-hour throughput, the material and design of the microscope are important. And here Axio Scope is a true Carl Zeiss microscope: robust stand design and superior mechanical quality.

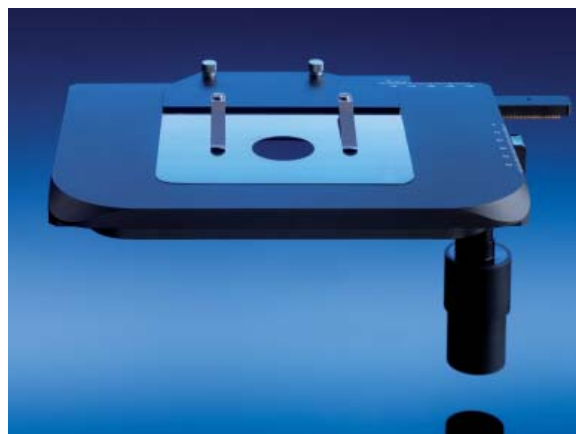

*With the smart slide guide the specimen can be moved around efficiently by hand. Alternatively, the more precise x/y stage control can be used at high magnification.*

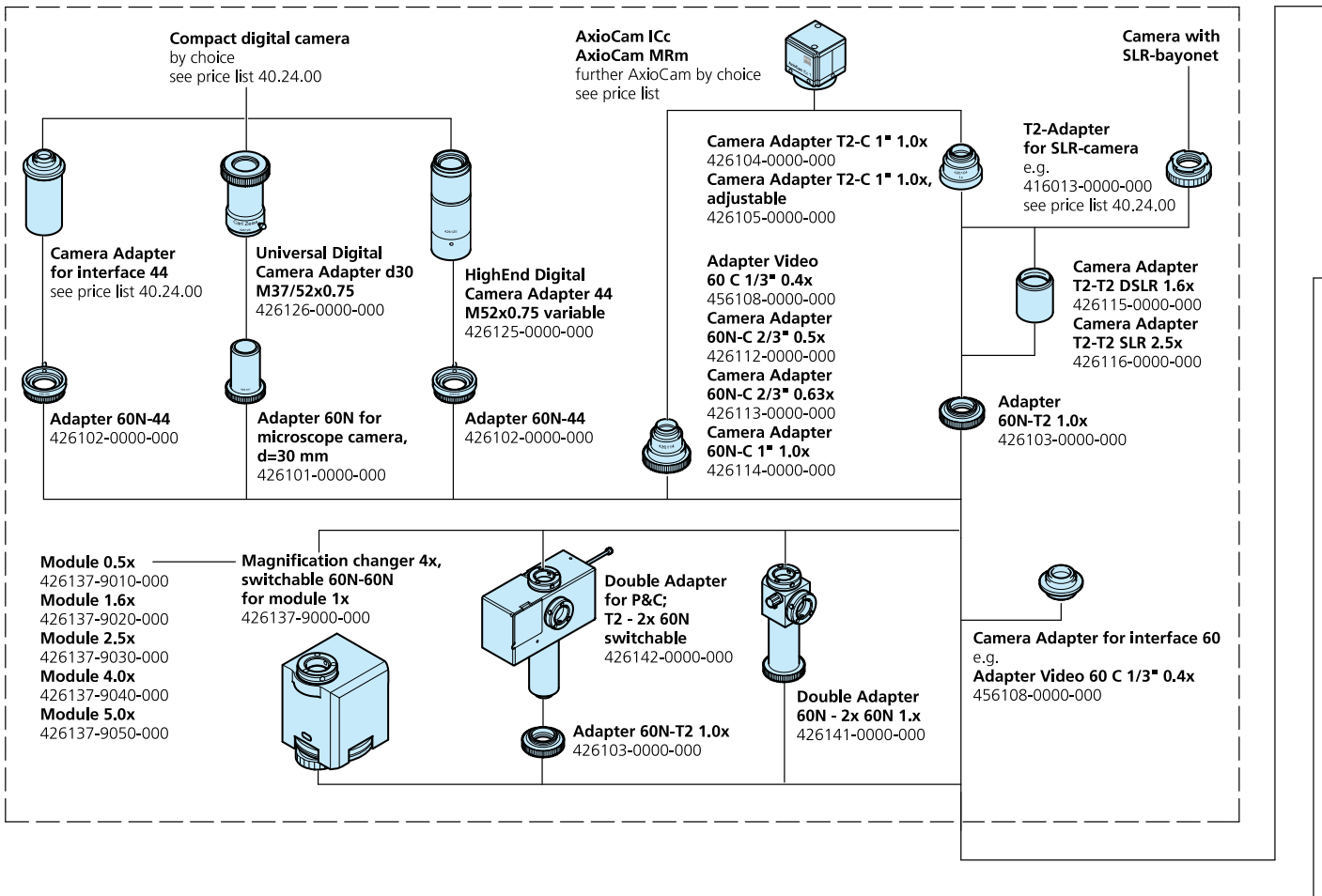

**3-position tube-lens turret with tube-lens 1x**  
425313-9010-000  
(only usable with the tubes:  
425500-0000-000  
425501-0000-000  
425503-9901-000  
425515-0000-000  
in combination with SF 23 eyepieces)

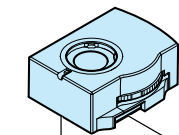

**Tube-lens 1.25x**  
425303-0000-000

**Tube-lens 1.6x**  
425304-0000-000

**Tube-lens 2.5x**  
425305-0000-000

**Tube-lens 4.0x**  
425307-0000-000

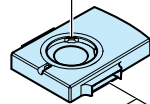

**Intermediate plate for analyzer slider 12x46**  
425313-9020-000  
(not usable with Ergotubes and Ergophototubes with vertical adjustment)

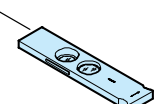

**Analyzer slider D/A, fixed**  
428101-0000-000

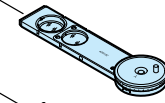

**Analyzer slider D/A with lambda-plate rotatable 360°**  
428102-0000-000

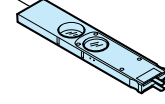

**Analyzer slider D/A, 360° rotatable**  
428103-0000-000

**Analyzer slider D/A with lambda-plate, each rotatable +/- 10**  
453663-9901-000

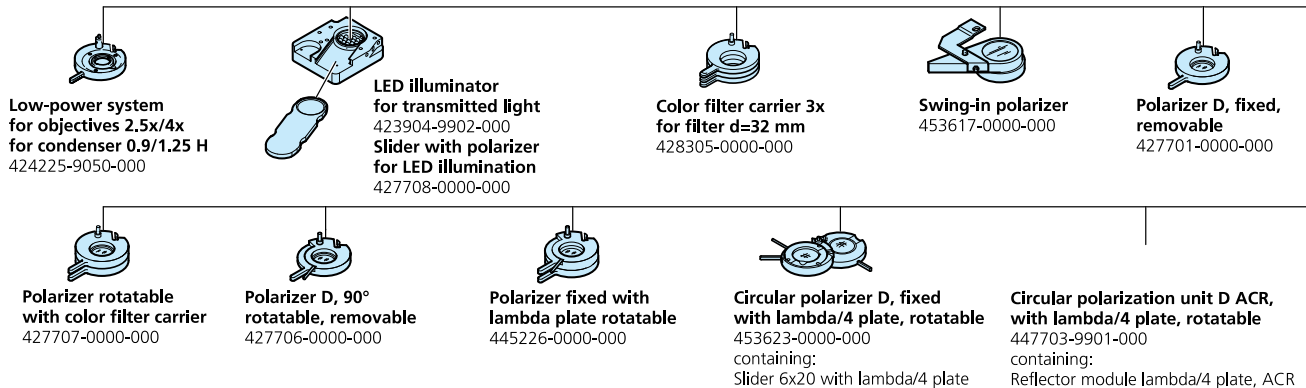

1

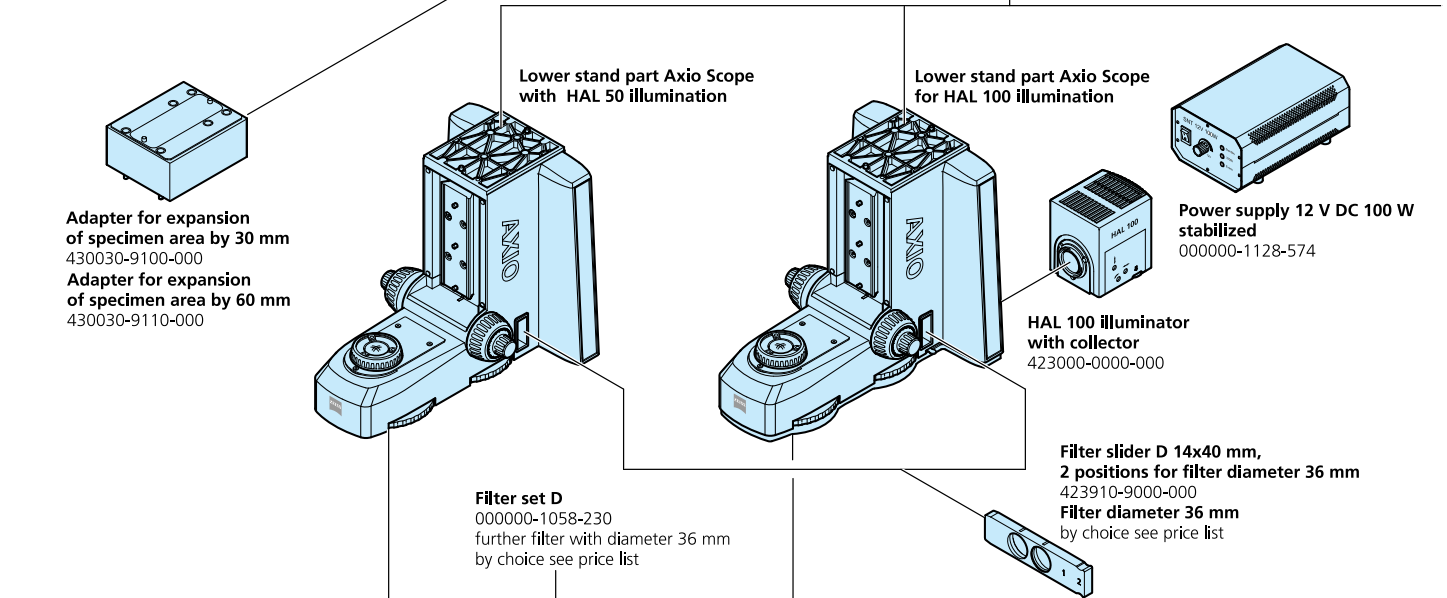
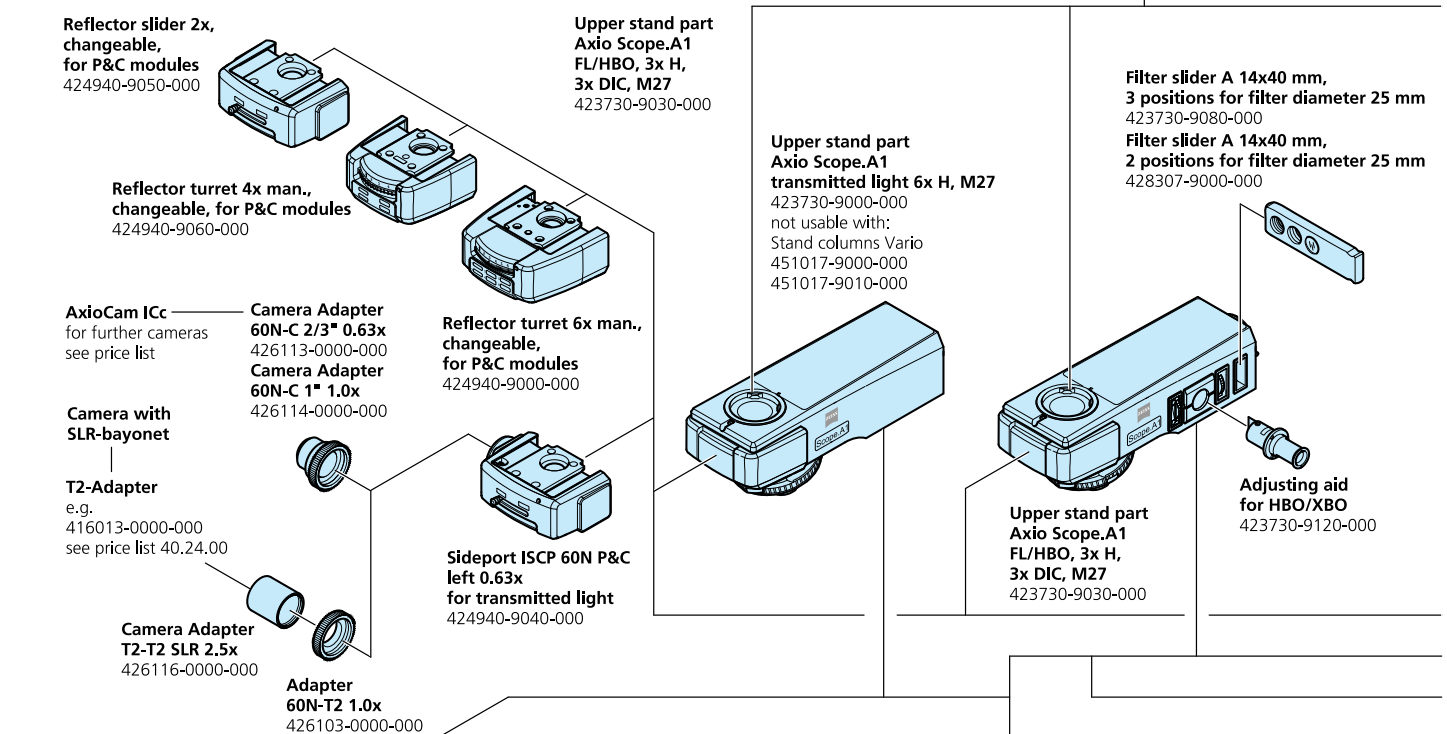
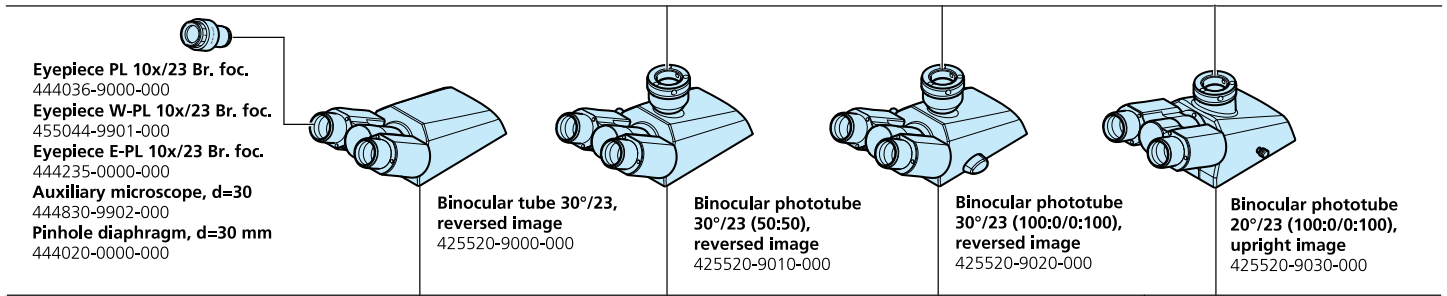

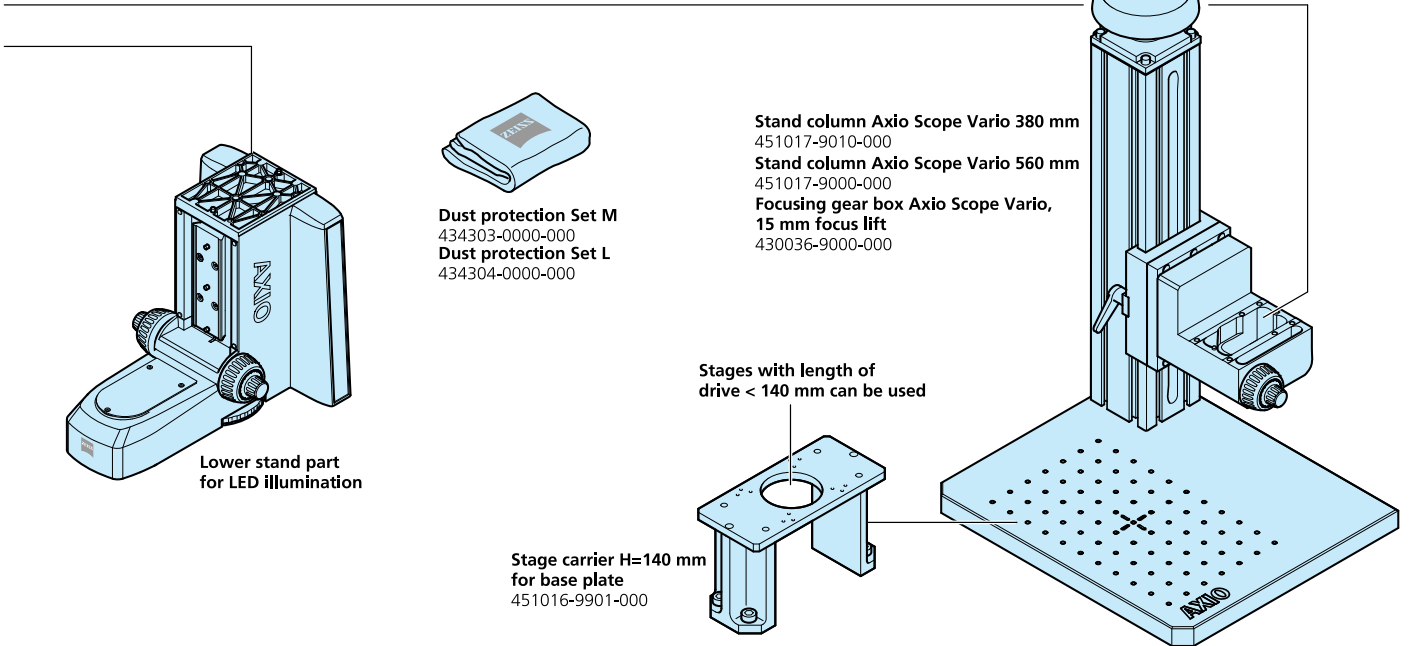
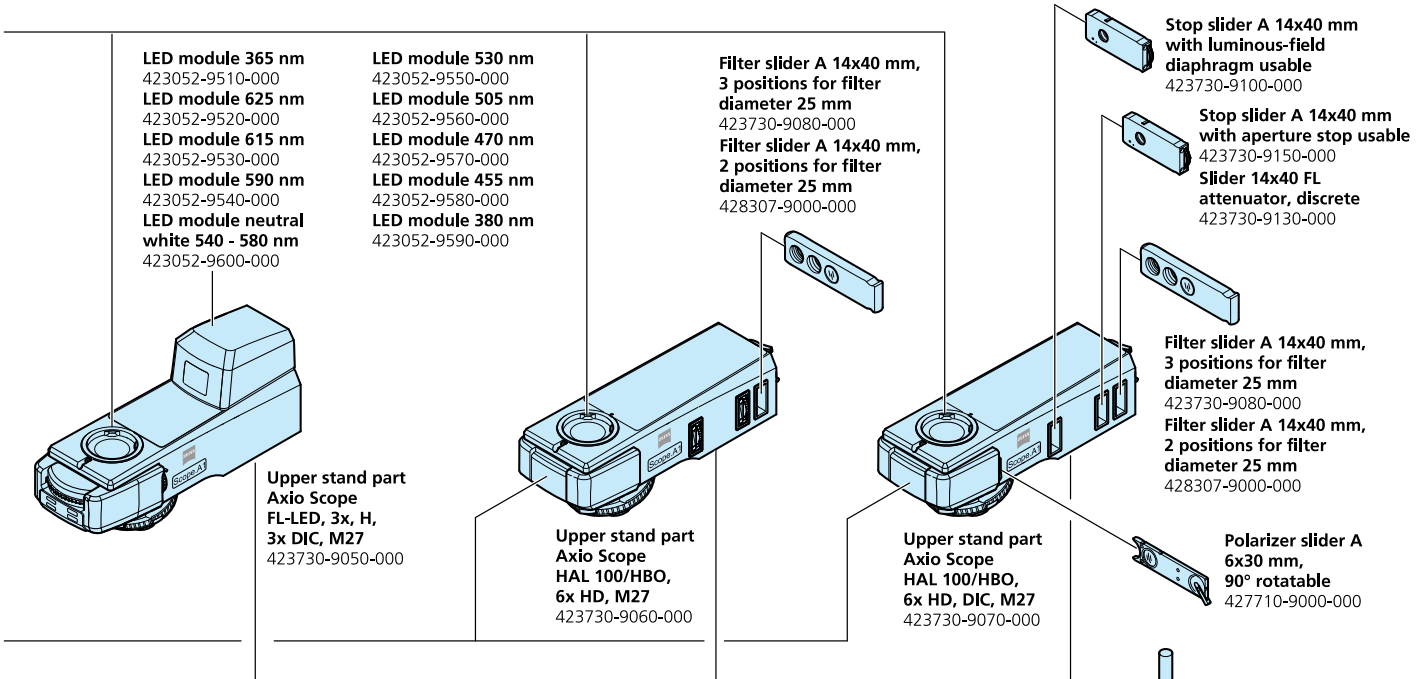
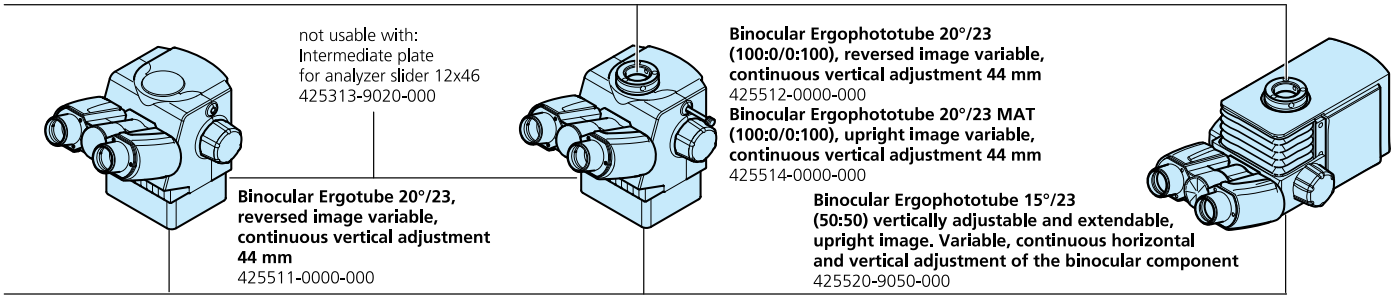

**Specimen holder for mechanical stage 75x50 for one-hand operation**  
000000-1067-330

**Specimen holder, special, for 2 specimen sliders 76 x 26 mm**  
000000-1070-589

**Universal mounting frame for Petri dishes and specimen sliders**  
453546-0000-000

**Heatable universal mounting frame A-H**  
000000-1116-055  
required:  
**Tempcontrol 37 (1 cannal)**  
000000-1116-057

**Specimen holder basic for one-hand operation, spring lever left**  
432333-9000-000

**Specimen holder plate for slides suitable for transmitted and reflected light**  
432333-9010-000

Further specimen holders by choice see price list 40.04.04

**Mechanical stage 75x50 R with hardcoat anodized surface**  
432035-9000-000

**Mechanical stage 75x50 R with special surface**  
432035-9070-000

**Mechanical stage 75x50 R ergon. drive, fixed position, with hardcoat anodized surface**  
432035-9010-000

**Mechanical stage 75x50 R with hardcoat anodized surface coaxial drive 160 mm**  
432035-9030-000

**Mechanical stage 75x50 L with hardcoat anodized surface coaxial drive 160 mm**  
432035-9040-000

**Mechanical stage 75x50/240° R with hardcoat anodized surface coaxial drive 160 mm**  
432035-9050-000

**Mechanical stage 75x50 R with electronic vernier scales with hardcoat anodized surface coaxial drive right 160 mm**  
432035-9060-000

**Display unit SCD 5**  
000000-1223-336

**Mechanical stage 75x50 R for reflected light with hardcoat anodized surface**  
453527-9903-000

**Reflected light measuring stage 105x105 R**  
000000-1223-326

**Rotary stage Pol with clamping device including 2 stage clips**  
000000-1128-332  
not usable with condenser 424225-9000-000

**Mechanical stage 75x50 mot with control unit MCX-2 ECO**  
000000-1025-145

optional:  
**Joystick for 2 axis**  
000000-1033-996  
or  
**Coaxial electronic drive**  
000000-1034-960

**Mechanical stage 75x50 R for Tetrad with Y-clickstops**  
432035-9080-000

**Condenser module DIC I/0.9 with polarizer**  
426715-9020-000

**Condenser module DIC II/0.9 with polarizer**  
426715-9030-000

**Condenser module DIC III/0.9 with polarizer**  
426715-9040-000

**Condenser, achrom.-aplan. 0.9 H**  
424225-9060-000

**Condenser, achrom.-aplan. 0.9 H D Ph DIC**  
424225-9070-000

**Slit-diaphragm 2 mm for PlasDIC**  
426715-9000-000

**Slit-diaphragm 4.5 mm for PlasDIC**  
426715-9010-000

**Modulator disk H, D 0.65, Ph 1, 2, 3 for condenser 0.9/1.25**  
424225-9010-000

**Condenser 0.9/1.25 H**  
424225-9000-000

**Dry darkfield condenser 0.8/0.95 (0.6/0.75)**  
465505-0000-000

**Ultra condenser 1.2/1.4 (0.75-1.0)**  
465500-0000-000

**Condenser holder Z for darkfield condenser**  
445323-0000-000

**Condenser carrier with vertical adjustment on both sides**  
430720-9000-000

**Stage carrier D/A, attachable and vertically adjustable**  
430710-9000-000

**Stage carrier D/A, attachable and vertically adjustable, rotary**  
430710-9010-000

1

# System Overview

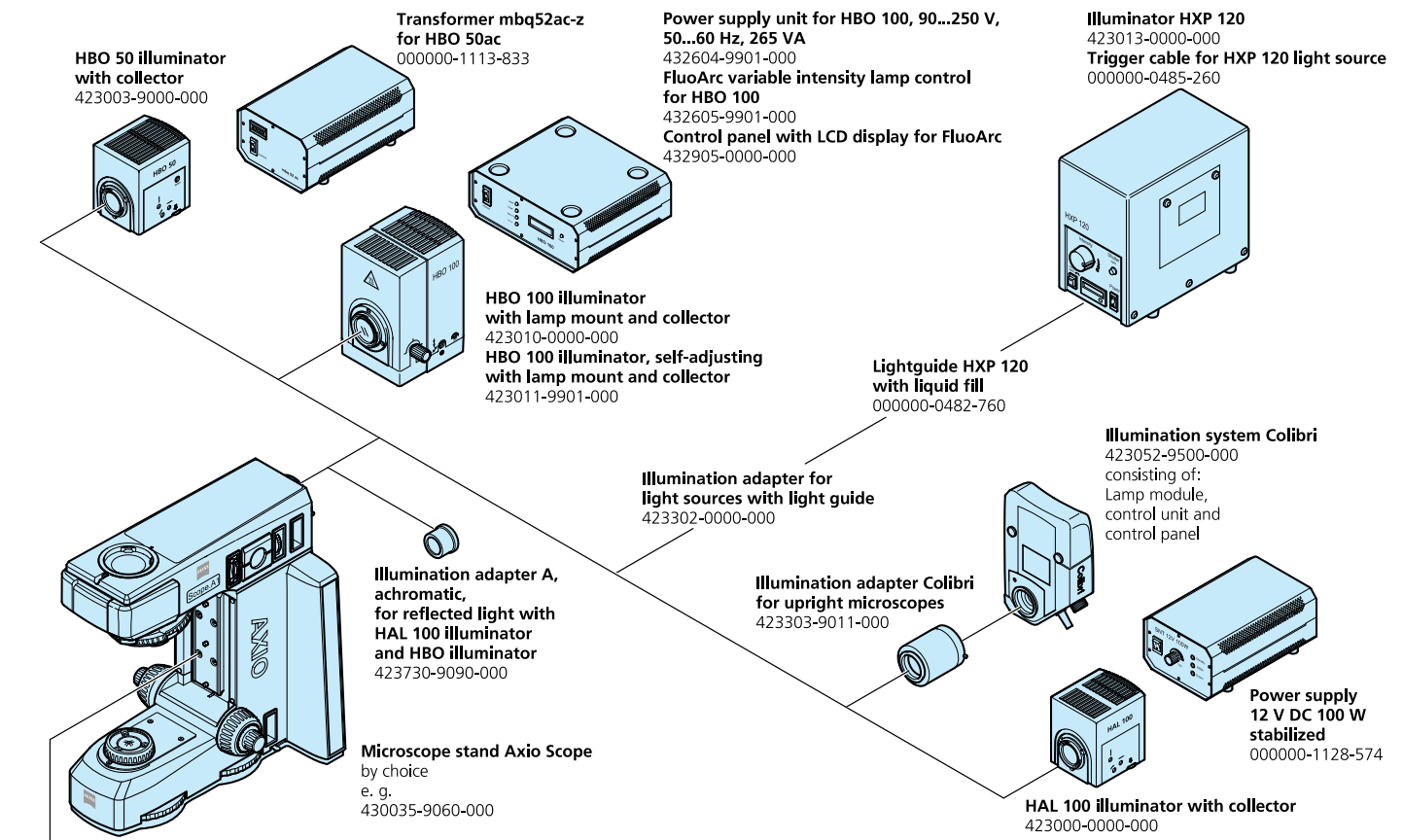
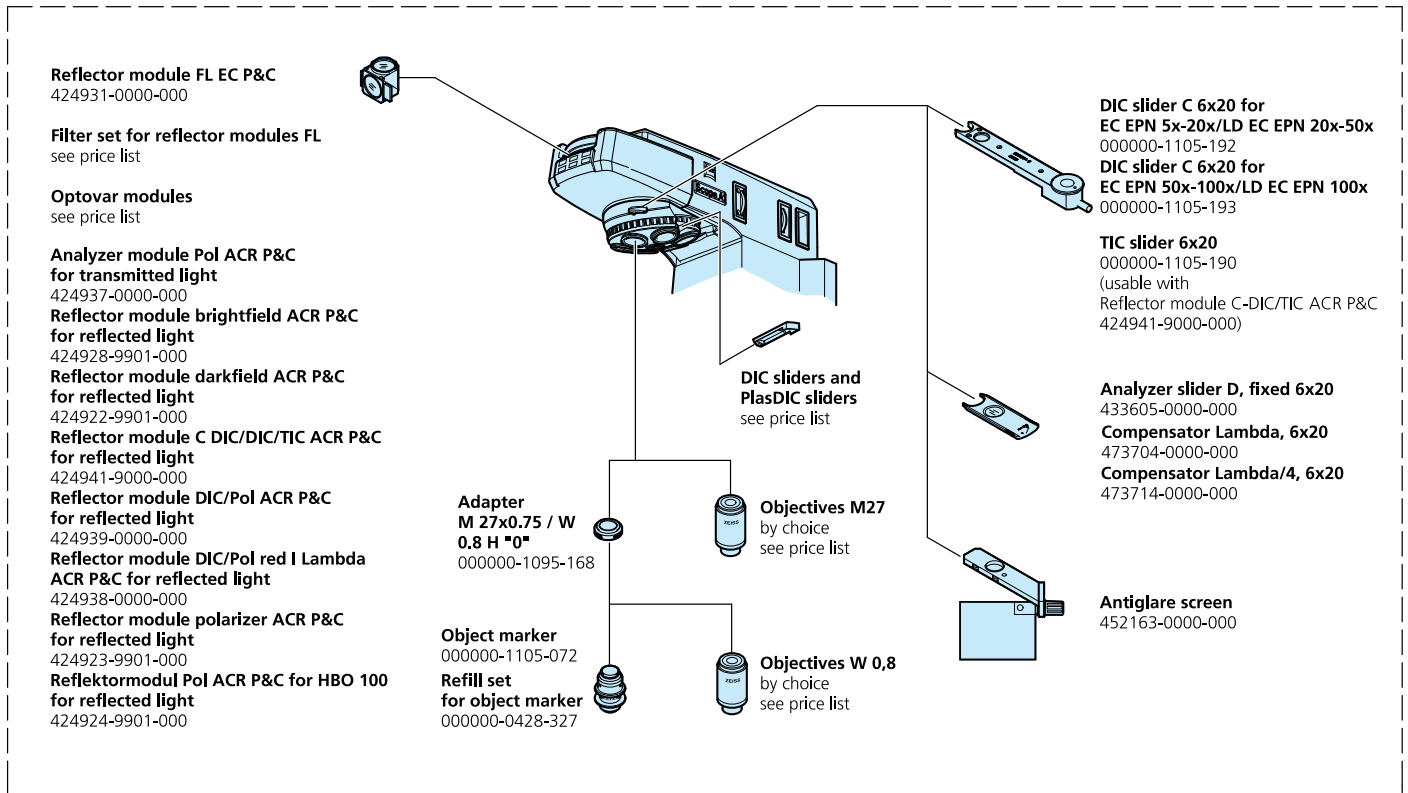



# The New Functionality

## All the Advantages

### **23 stand versions – a perfect solution**

You configure your Axio Scope from five upper parts, three lower parts and two vario columns. Made to measure for simple routine applications, for demanding research tasks, for every budget.

### **Countless interfaces**

An unusual number of interfaces allows exact adaptation to requirements and budget.

### **Economical upgrading**

Many components can be added on by the customer as needed – easily and without additional service costs.

### **PlasDIC and DIC now in an upright microscope**

In response to many customers a choice of two sophisticated contrasting techniques is available in an upright microscope for the first time: Differential Interference Contrast, DIC, and PlasDIC, the inexpensive relief contrast.

### **LED in transmitted-light – LED in fluorescence**

Axio Scope offers integrated solutions with these extremely long-lasting and economical light sources, not only in transmitted-light but also in reflected-light – thus taking into account the growing importance of fluorescence as a routine method.

### **HBO 50 innovation**

Newly developed for Axio Scope, the burner can now be removed with the drawer – for a particularly easy and comfortable change of burner.

### **A variety of reflector inserts**

Through its customer interface in the infinity space, Axio Scope allows users to select the reflector insert most suitable for the respective application. There is a choice of a 2x slider, a 4x reflector turret and a 6x reflector turret.

### **ISCP – innovative option for transmitted-light applications**

The interface in the infinity space can be used not only in reflected-light (see above, use of reflectors) but also in transmitted-light: as a fully functioning camera port. Independent of the tube, it can be added on any time.

### **N-ACHROPLAN objectives – perfect for routine work**

The inexpensive, completely new developed objective series has been calculated for a field of view of 23 mm and is versatile for various applications.

### **Flexibility of the specimen space**

Axio Scope offers unusually large scalability of the specimen space – for the most varied applications. Depending on the configuration, continuously adjustable for specimen thicknesses from 0 to 110 mm.

### **Convenient intensity adjustment**

The intensity adjustment of the transmitted-light illumination is arranged on both sides close to the focus drive and extremely comfortable to operate with the right or left hand.

### **New development: the ergo-stage**

Newly developed in order to make hand positions individually adaptable and operation even more comfortable. The stage drive of the new ergo-stage can be pushed 90 mm along the y axis and fixed in the position that is most comfortable.

### **Stage for high specimen throughput**

With an extremely hard special coating, this new stage remains completely free from scratches even in a hardness test – ideal when a lot of specimen slides have to be moved on the stage.

### **Smart specimen guide**

Axio Scope specimen guide allows the slide to be moved alternatively by hand – an innovation that experienced pathologists in particular will welcome.

### **Conversion without tools**

Many of the components such as the stage carrier can simply be unscrewed without tools, e.g. for cleaning purposes.

**Carl Zeiss MicroImaging GmbH**

07740 Jena, Germany

BioSciences | Göttingen Location

Phone: +49 551 5060 660

Telefax: +49 551 5060 464

E-Mail: [micro@zeiss.de](mailto:micro@zeiss.de)

**[www.zeiss.de/axioscope](http://www.zeiss.de/axioscope)**